



**Pb-free
HEAT**



5364X Series

Single Color High Brightness ϕ 5 Type

Features

Package	ϕ 5 Round shape type, YPY,FY : Pale Yellow Clear epoxy FA : Pale Orange Clear epoxy FR : Pale Red Clear epoxy
Product features	<ul style="list-style-type: none"> • Outer Dimension ϕ 5 Round shape type • Operation temperature range. Storage Temperature : -40°C~100°C Operating Temperature : -40°C~85°C • Lead-free soldering compatible • RoHS compliant
Dominant wavelength	Yellow Green : 572nm (YPY) Yellow : 590nm (FY) Orange : 605nm (FA) Red : 626nm (FR)
Half Intensity Angle	YPY,FY,FA,FR : 35 deg.
Die materials	YPY,FY,FA,FR : AlGaInP
Rank grouping parameter	Sorted by luminous intensity per rank taping
Soldering methods	TTW (Through The Wave) soldering and manual soldering
ESD	AlGaInP : More than 2kV(HBM)
Packing	Bulk : 200pcs(MIN.)

Recommended Applications

Amusement Equipment, Electric Household Appliances, OA/FA, Other General Applications

Color and Luminous Intensity

(Ta=25°C)

Part No.	Material	Emitted Color	Lens Color		Dominant Wavelength λd (nm)		Luminous Intensity I_v (mcd)		
					TYP.	I_F	MIN.	TYP.	I_F
					YPY5364X	AlGaInP	Yellow Green	Pale Yellow	Clear
FY5364X	AlGaInP	Yellow	590	20	320	640	20		
FA5364X	AlGaInP	Orange	Pale Orange	605	20	390	780	20	
FR5364X	AlGaInP	Red	Pale Red	626	20	290	580	20	

Absolute Maximum Ratings

(Ta=25°C)

Item	Symbol	Absolute Maximum Ratings				Unit
		YPY	FY	FA	FR	
Power Dissipation	P_d	130	125	125	125	mW
Forward Current	I_F	50	50	50	50	mA
Pulse Forward Current ※1	I_{FRM}	200	200	200	200	mA
Derating (Ta=25°C or higher)	ΔI_F	0.67	0.67	0.67	0.67	mA/°C
Reverse Voltage	V_R	5	5	5	5	V
Operating Temperature	T_{opr}	-40~+85				°C
Storage Temperature	T_{stg}	-40~+100				°C

 ※1 I_{FRM} Measurement condition : Pulse Width ≤ 1 ms., Duty $\leq 1/20$.

Electro-Optical Characteristics

(Ta=25°C)

Item	Conditions	Symbol	Characteristics				
			YPY	FY	FA	FR	
Forward Voltage	I _F =20mA	V _F	TYP.	2.1	1.9	1.9	1.9
			MAX.	2.5	2.4	2.4	2.4
Reverse Current	V _R =5V	I _R	MAX.	100	100	100	100
Peak Wavelength	I _F =20mA	λ_p	TYP.	575	592	609	635
Dominant Wavelength	I _F =20mA	λ_d	TYP.	572	590	605	626
Spectral Line Half Width	I _F =20mA	$\Delta \lambda$	TYP.	15	15	15	15
Half Intensity Angle	I _F =20mA	2 θ 1/2	TYP.	35	35	35	35

Luminous Intensity Rank

($T_a=25^\circ\text{C}$)

Rank	I_v (mcd)								Condition
	YPY		FY		FA		FR		
	MIN.	MAX.	MIN.	MAX.	MIN.	MAX.	MIN.	MAX.	
A	150	300	320	640	390	780	290	580	$I_F = 20\text{mA}$
B	210	420	450	900	550	1,100	410	820	
C	300	600	640	1,280	780	1,560	580	1,160	
D	420	840	900	1,800	1,100	2,200	820	1,640	
E	600	-	1,280	-	1,560	-	1,160	-	

*Please contact our sales staff concerning rank designation.

Technical Data(YPY)

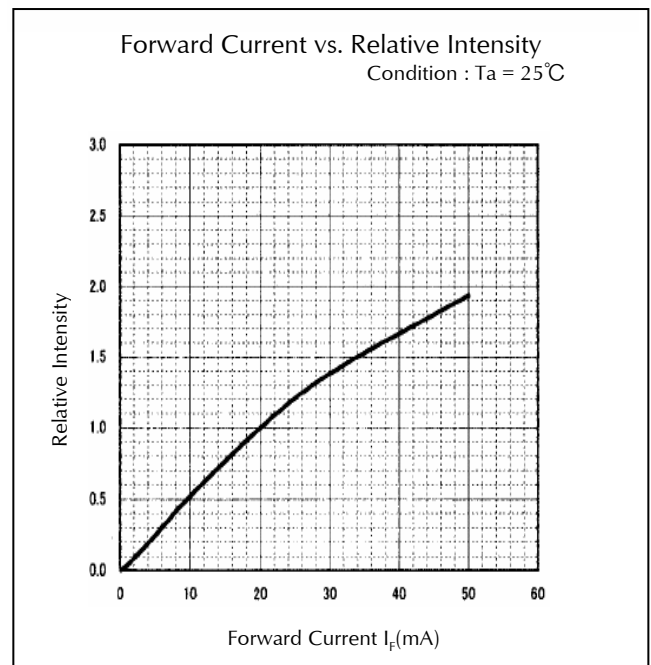
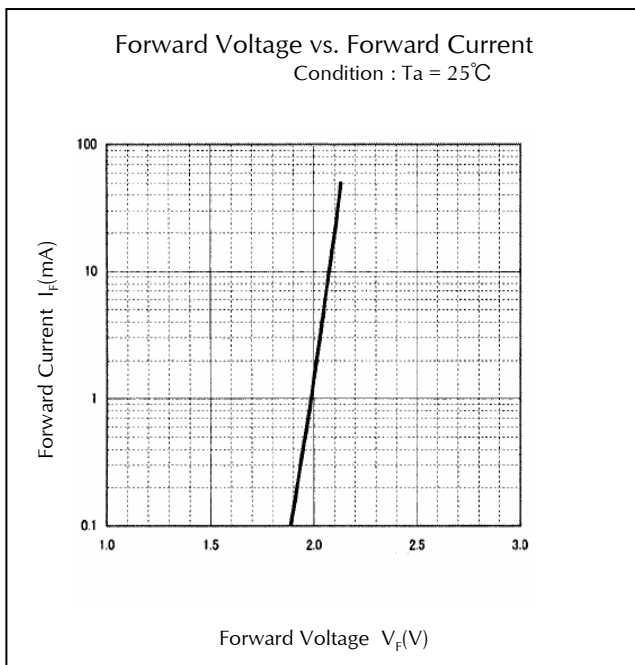
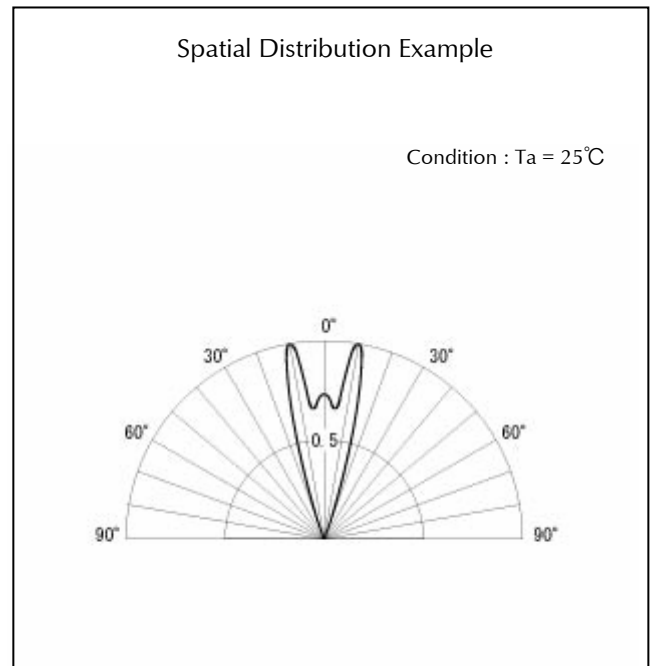
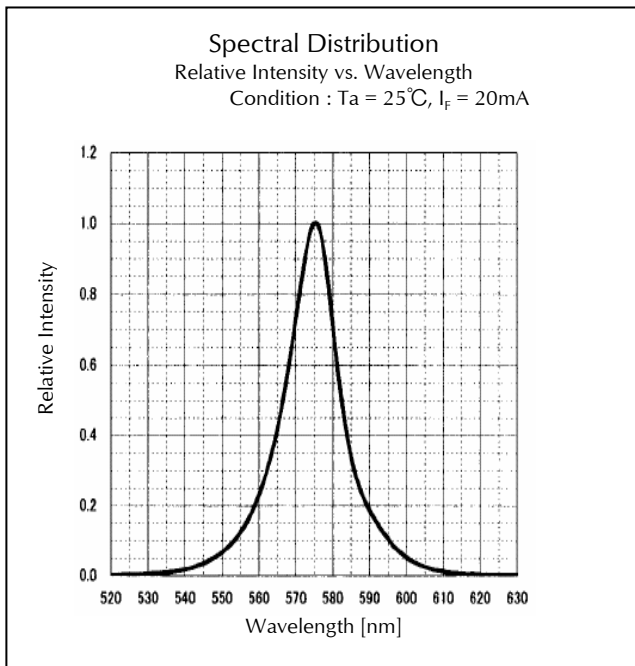

Technical Data (YPY)

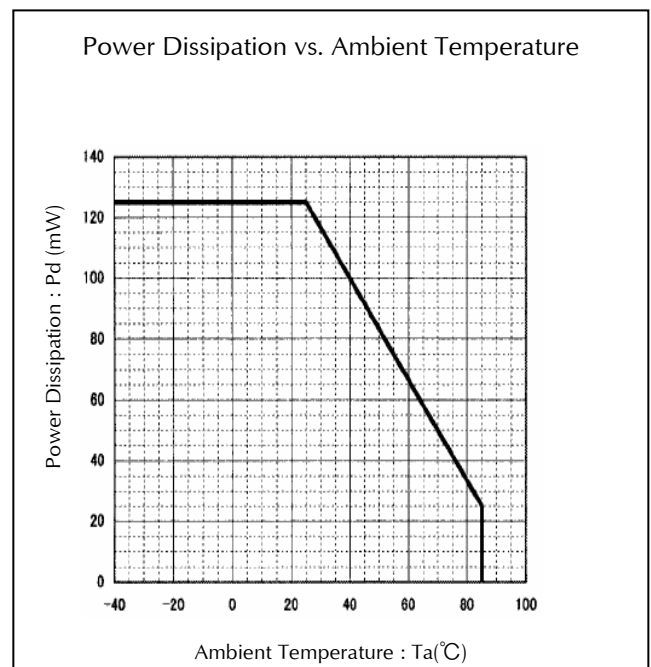
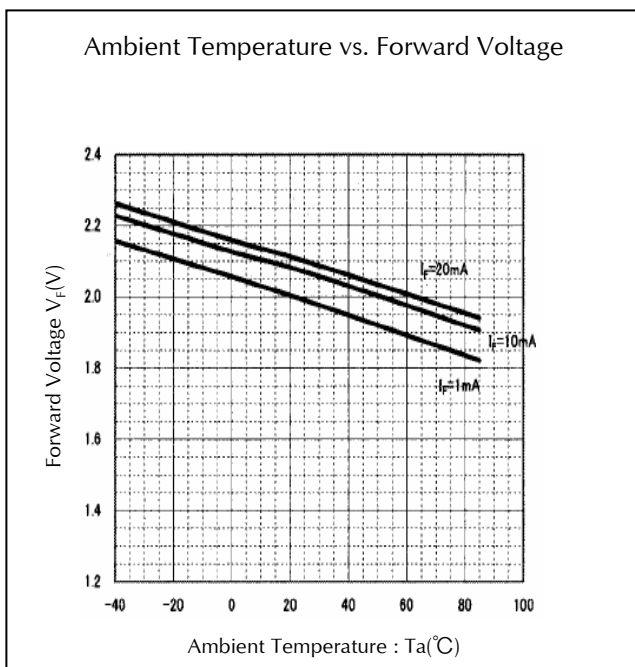
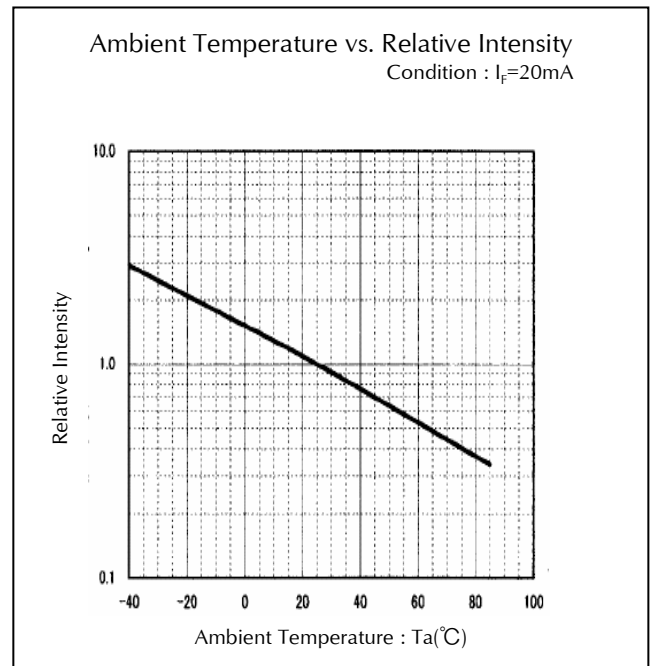
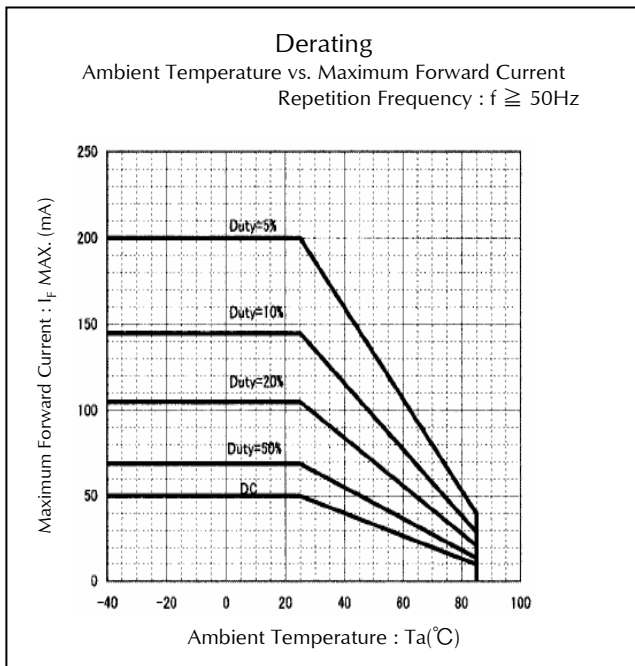

Technical Data(YPY)

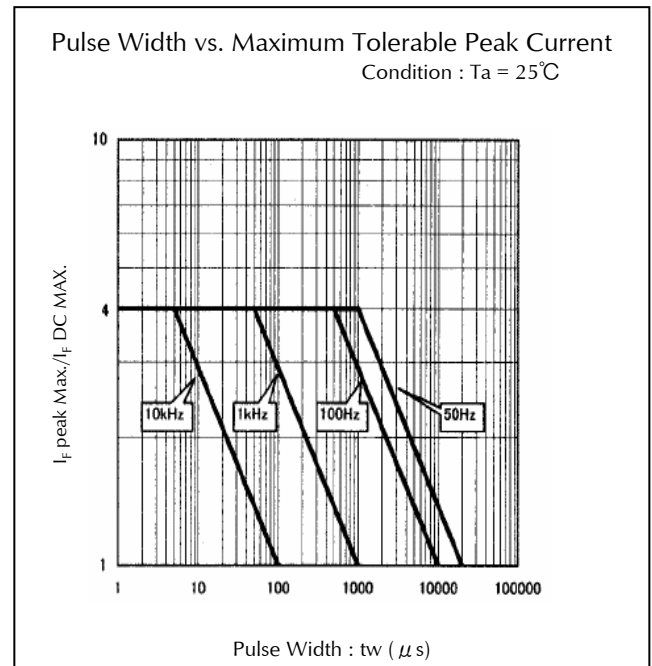
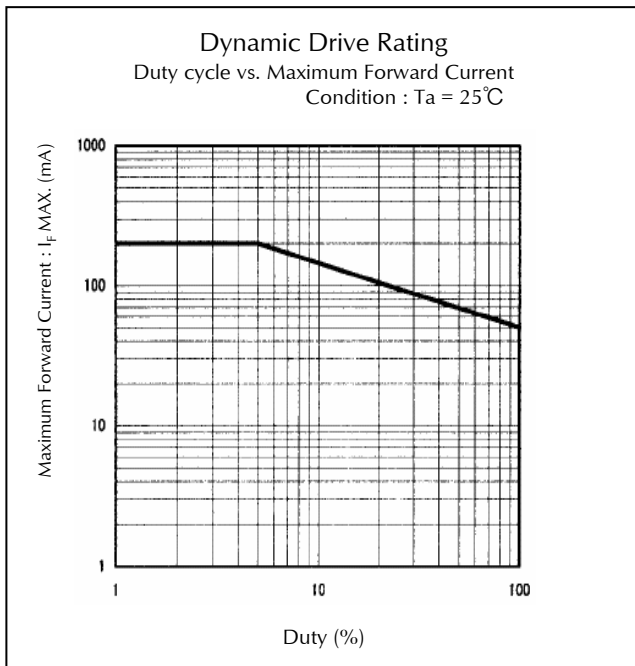

Technical Data(FY)

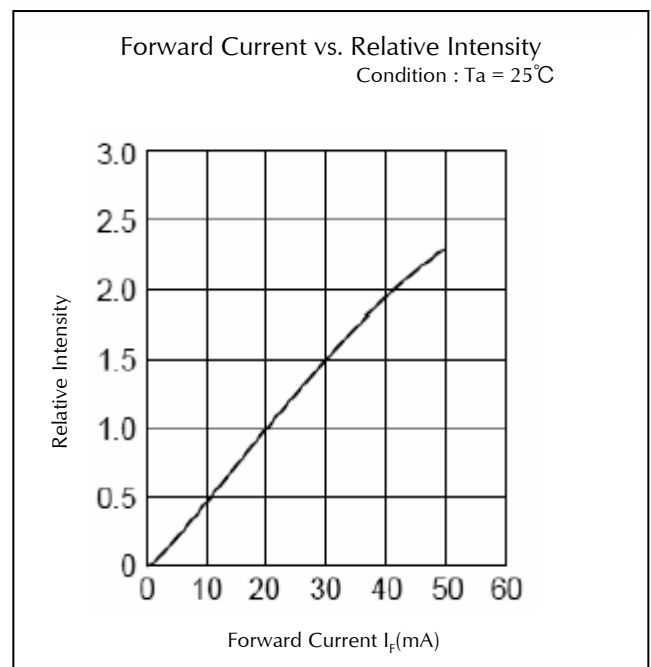
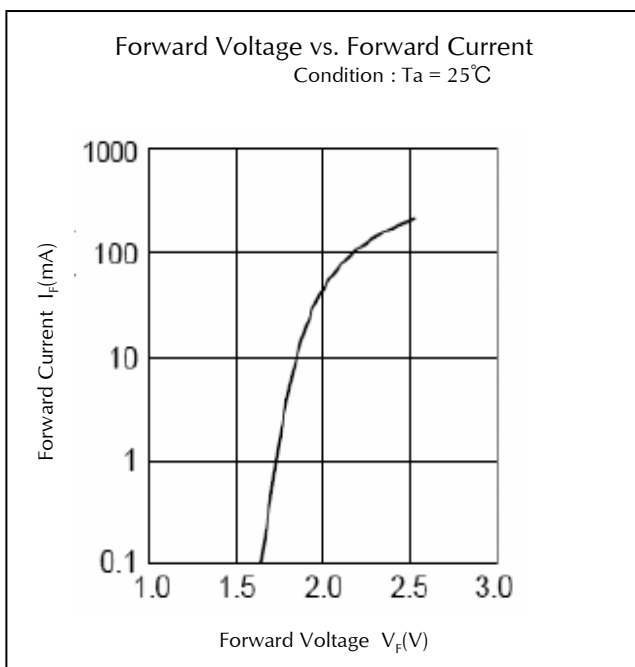
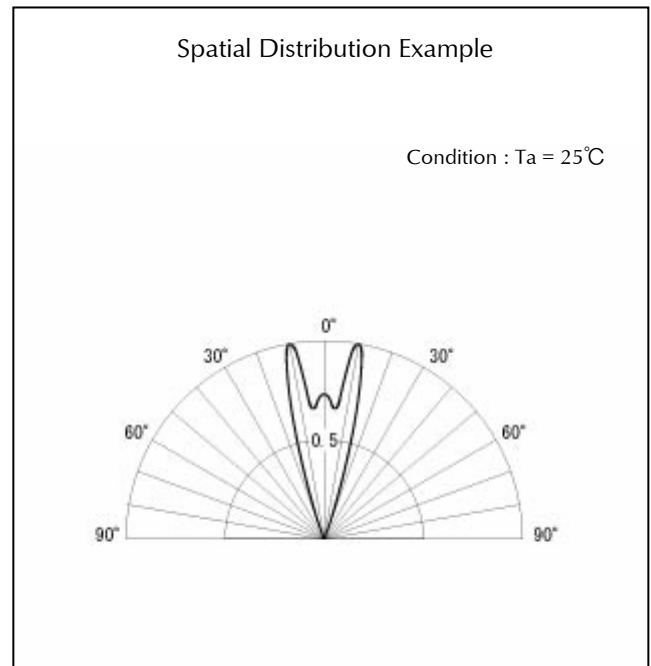
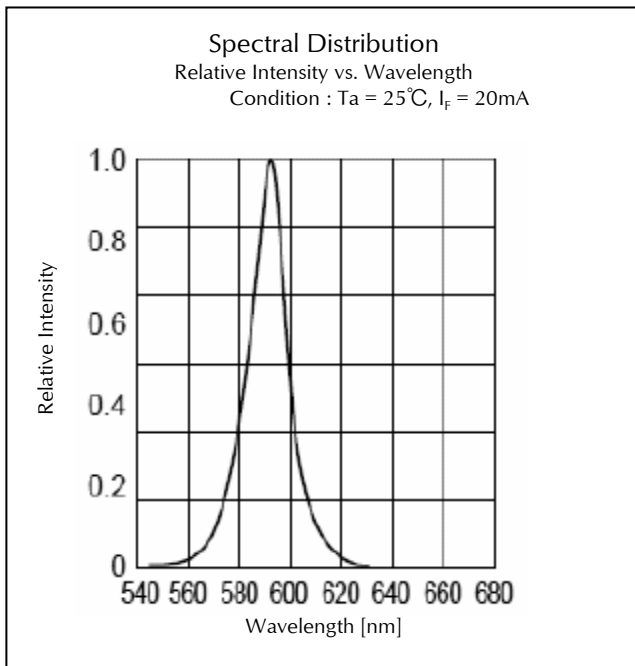

Technical Data(FY)

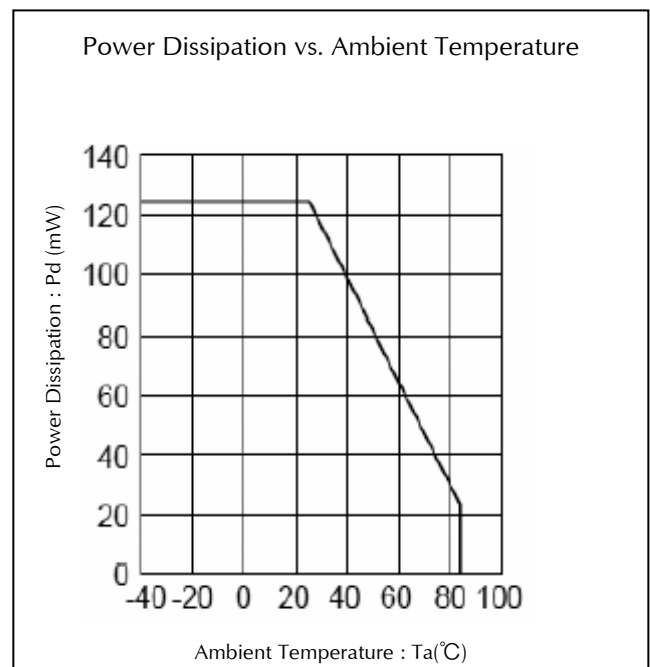
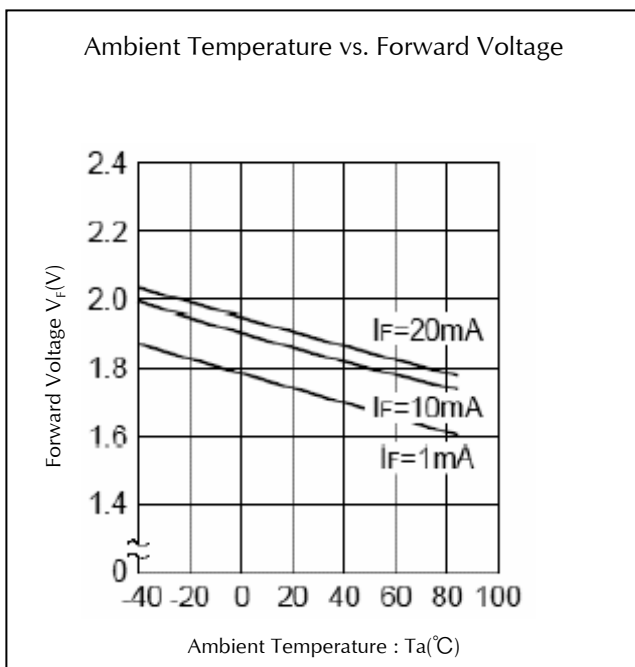
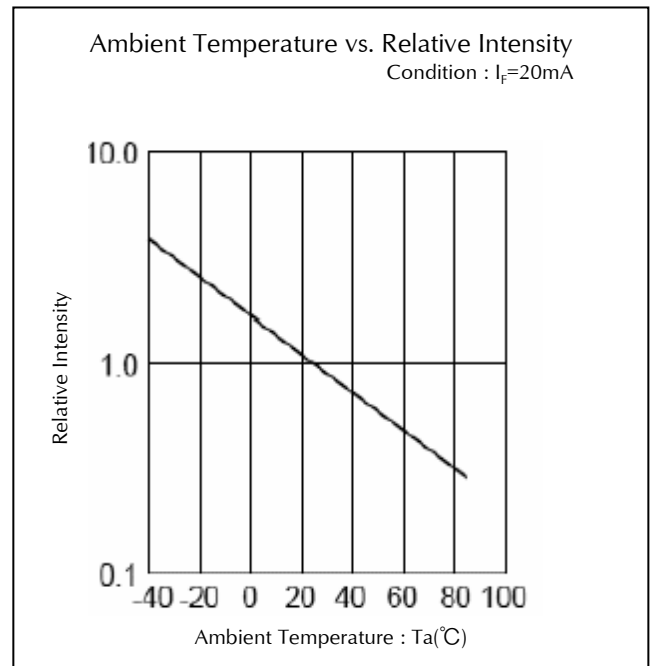
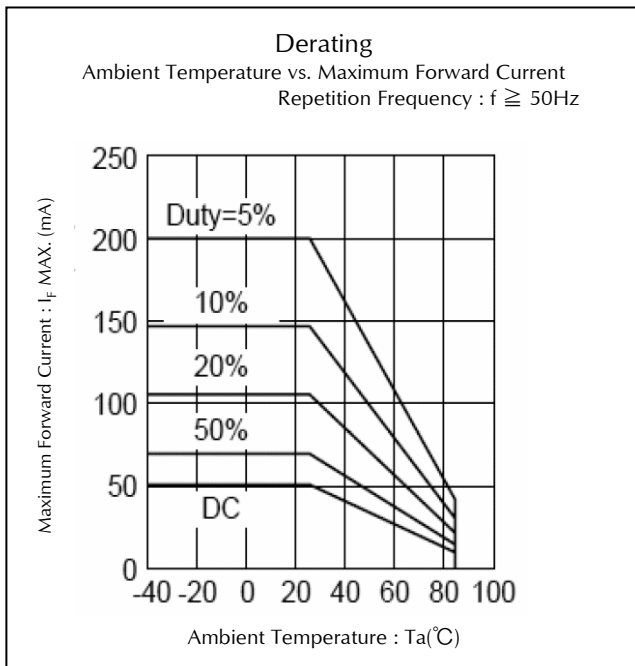

Technical Data(FY)

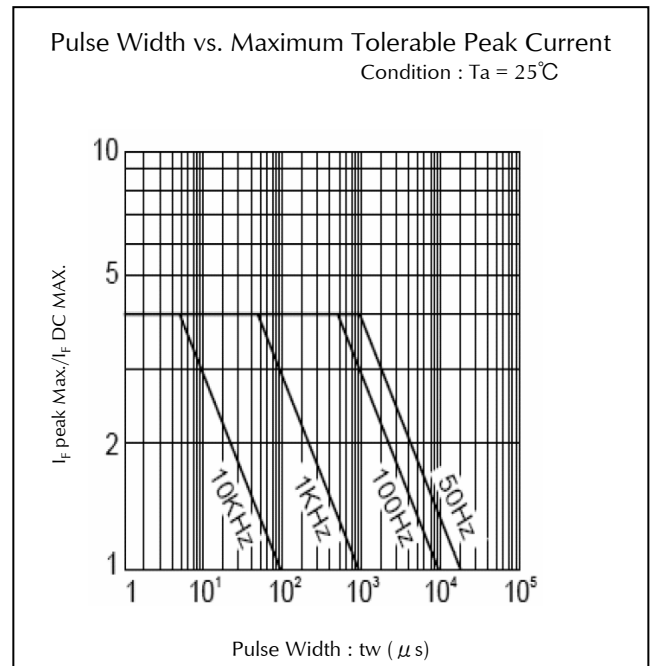
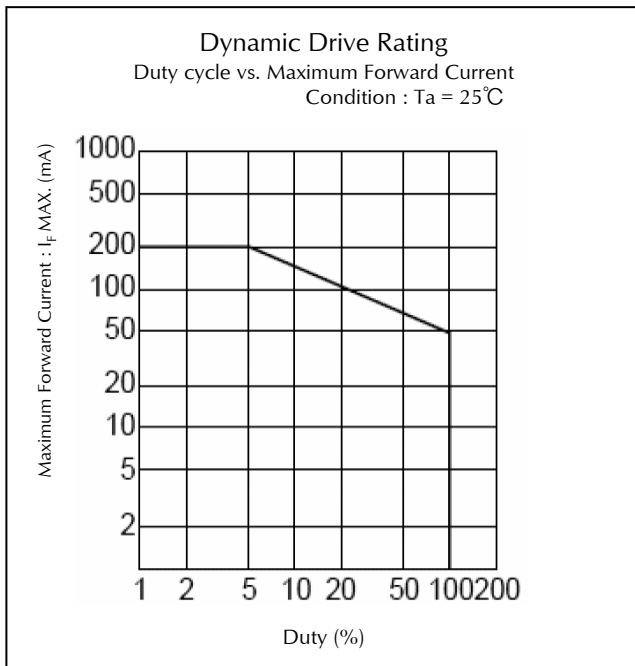

Technical Data(FA)

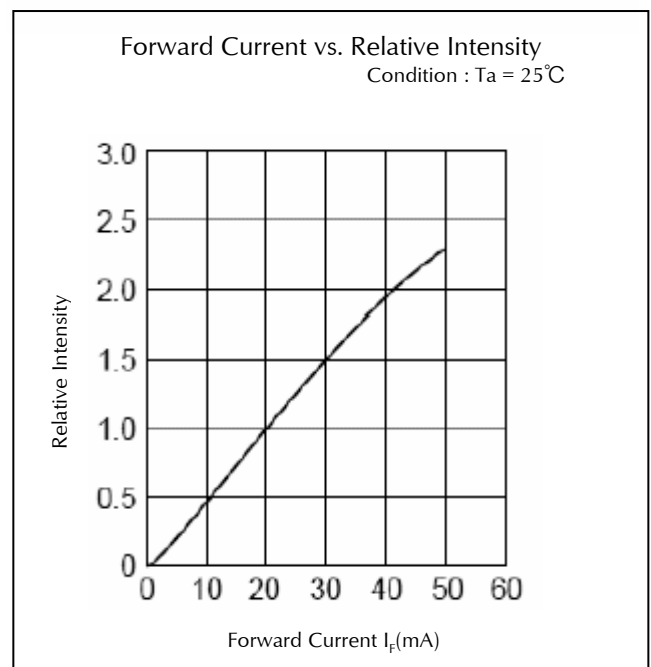
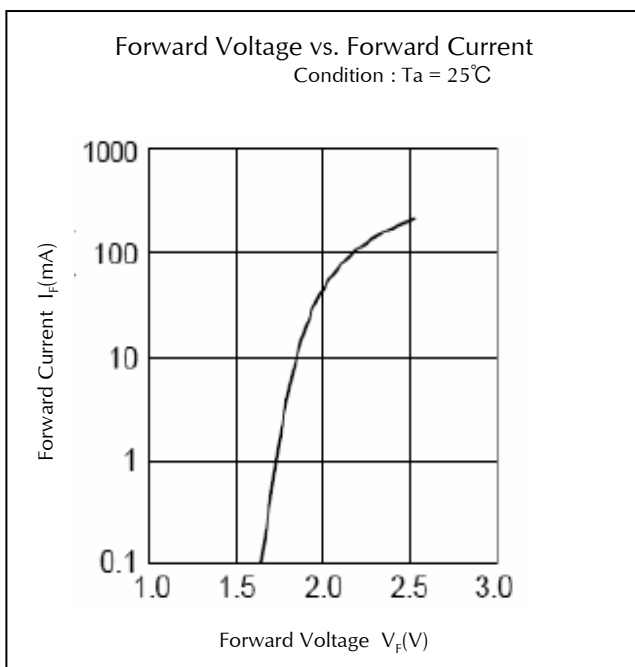
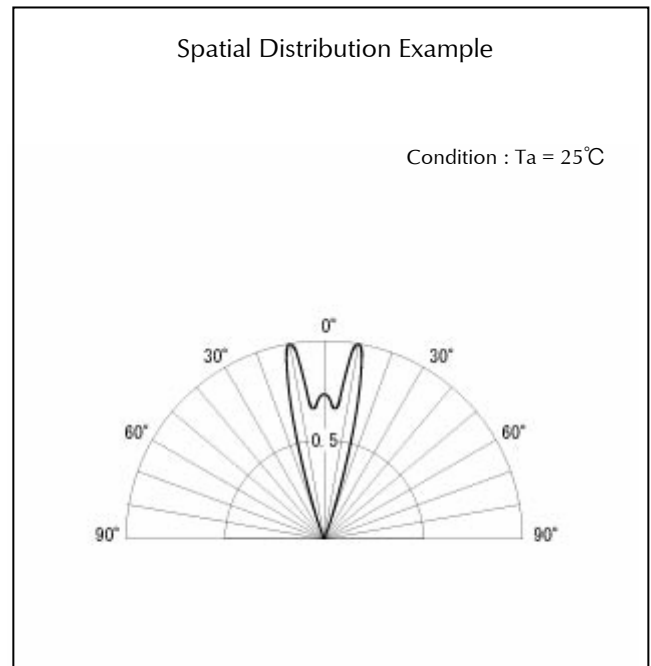
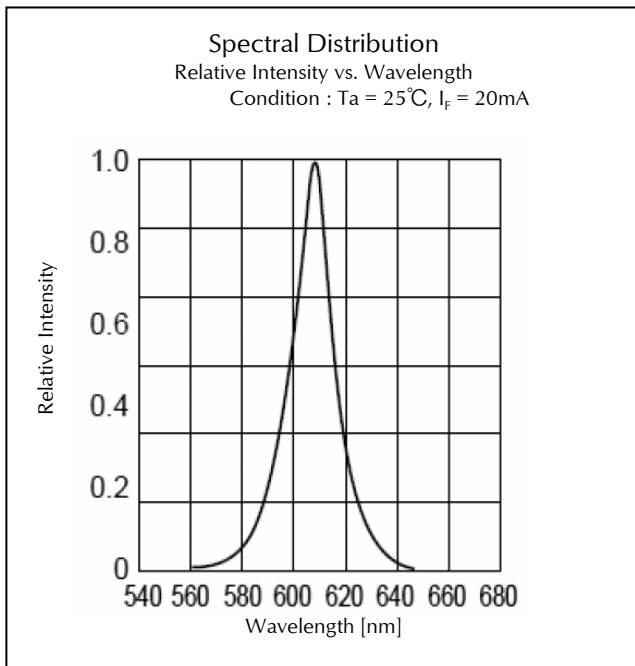

Technical Data(FA)

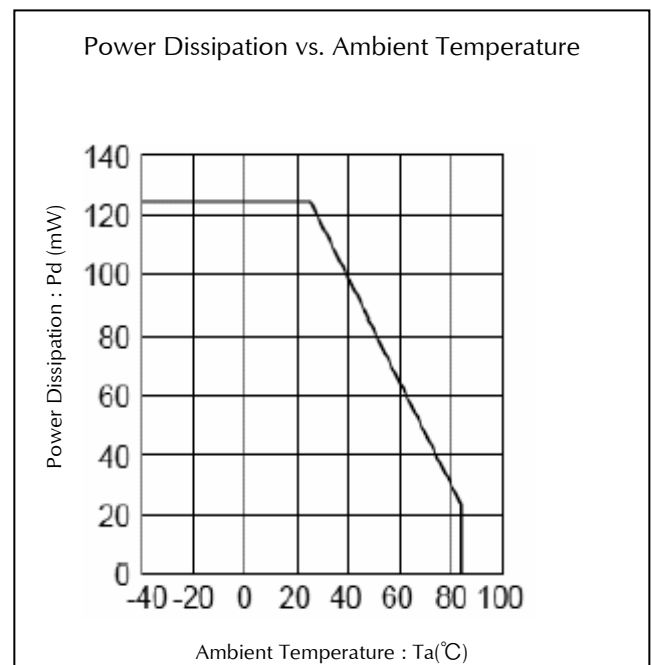
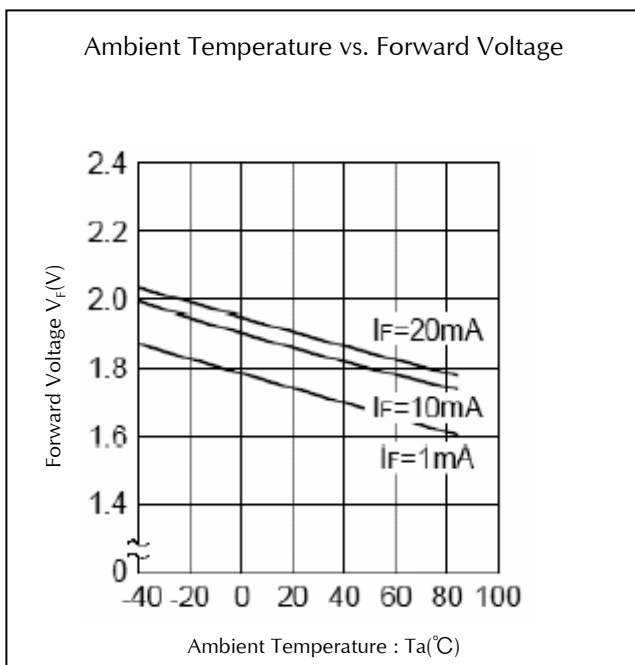
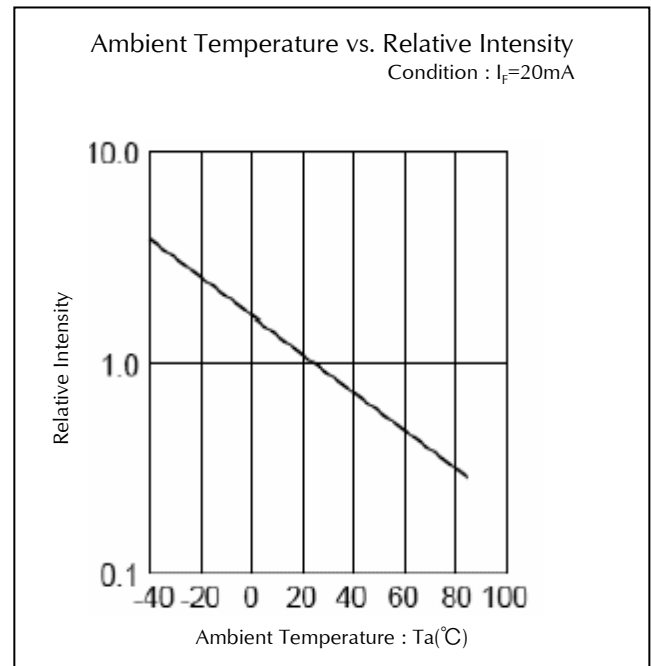
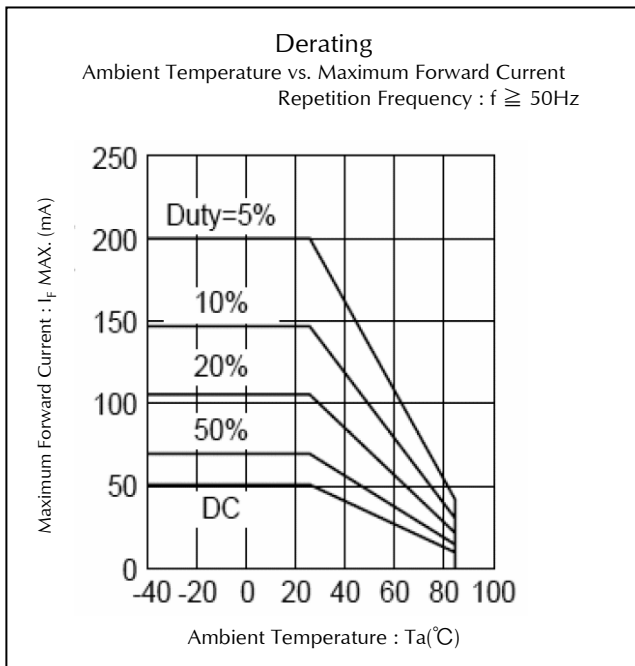

Technical Data(FA)

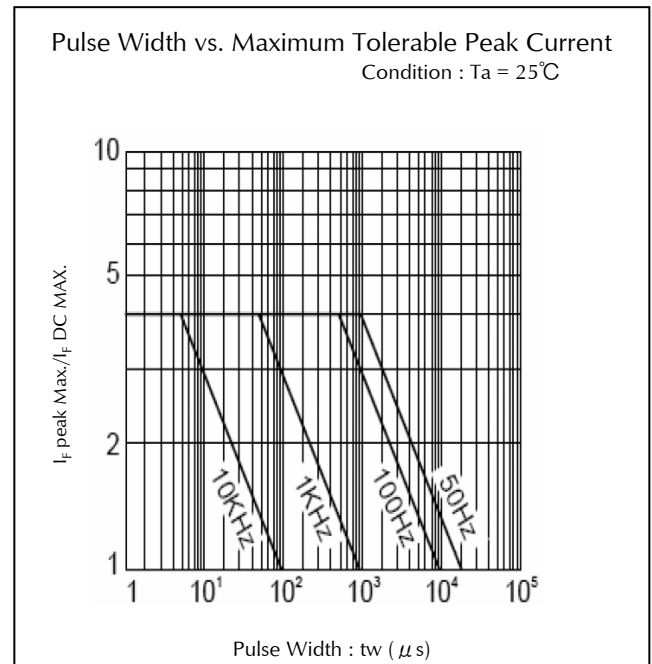
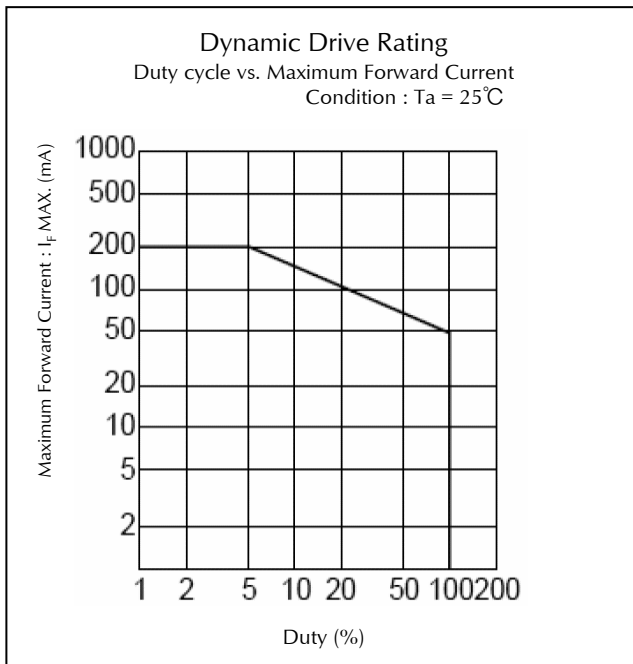

Technical Data(FR)

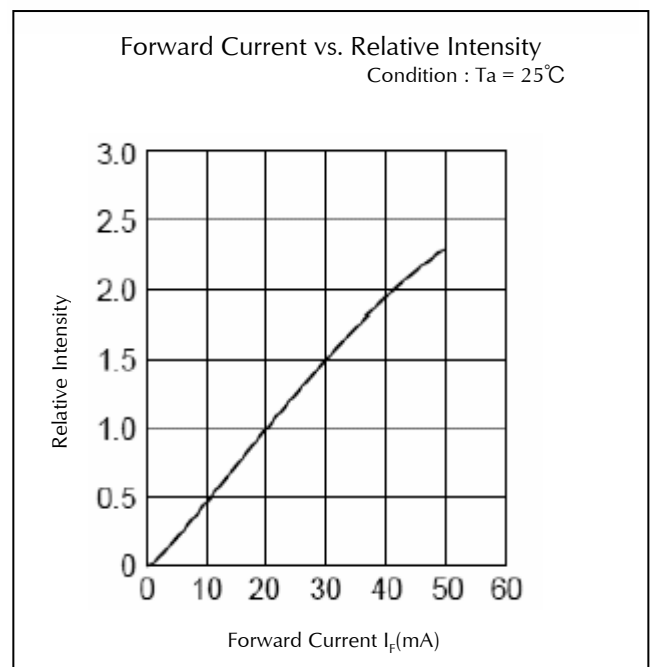
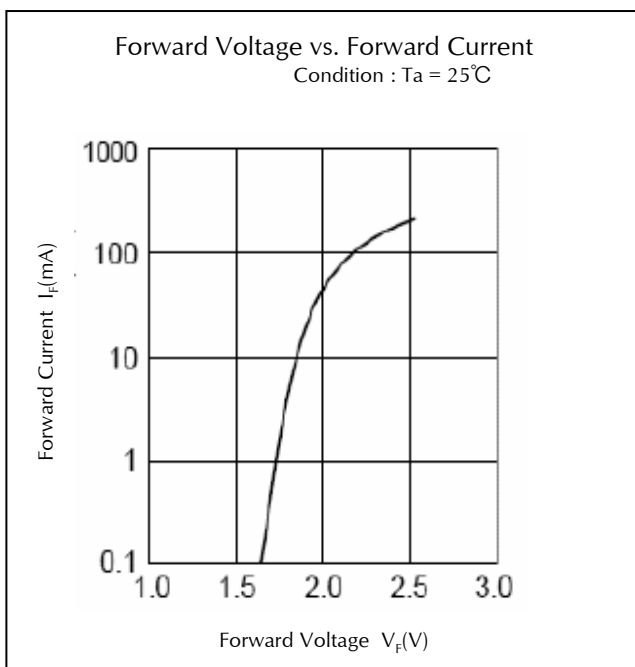
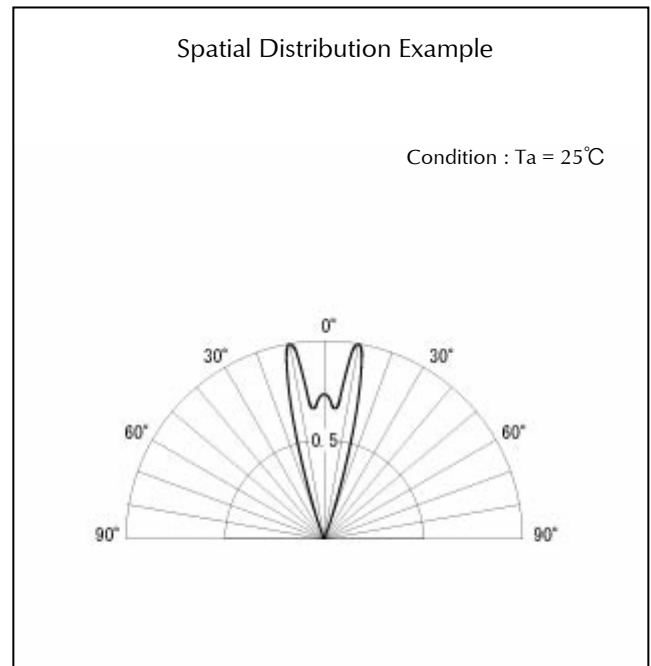
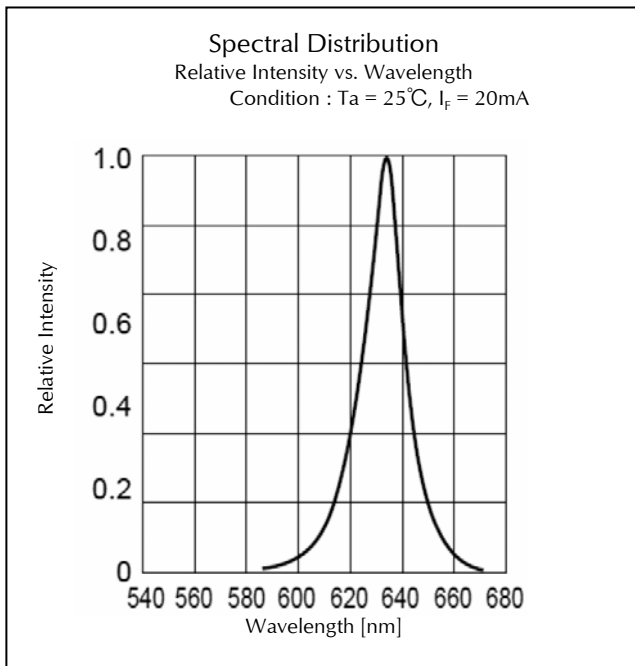

Technical Data(FR)

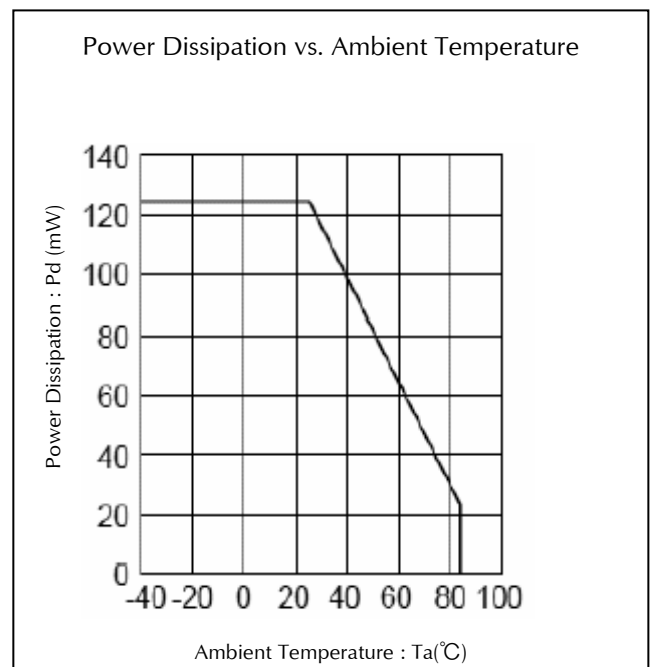
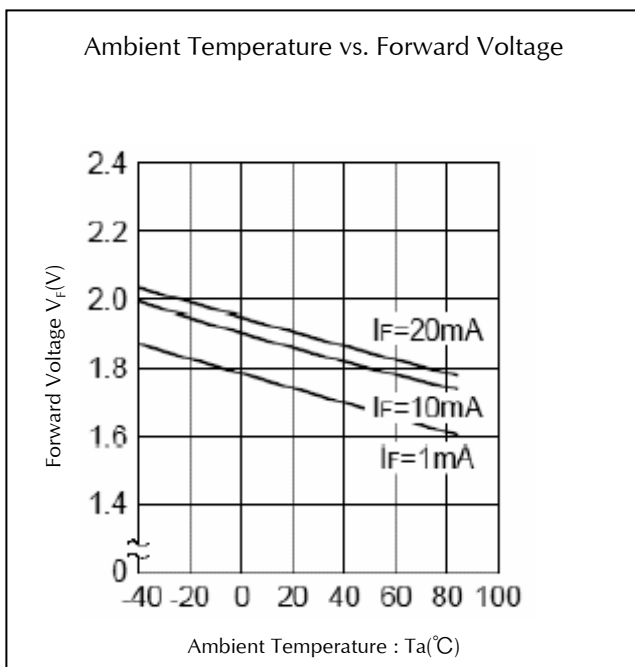
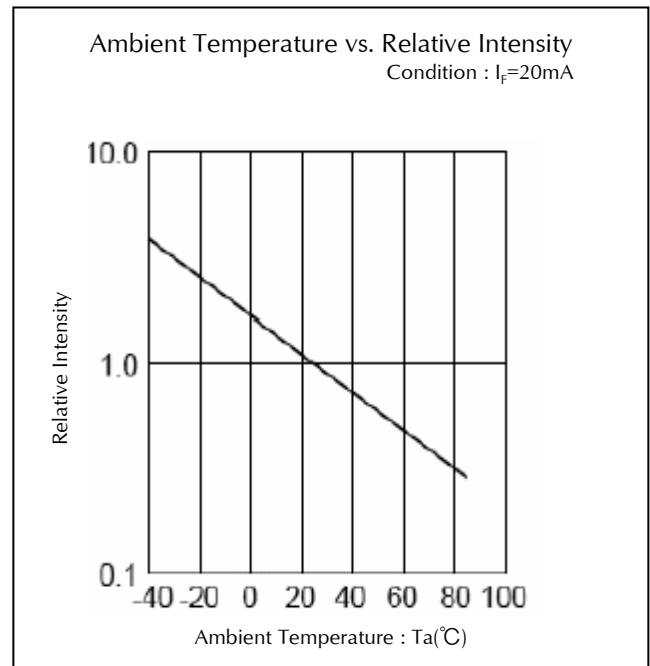
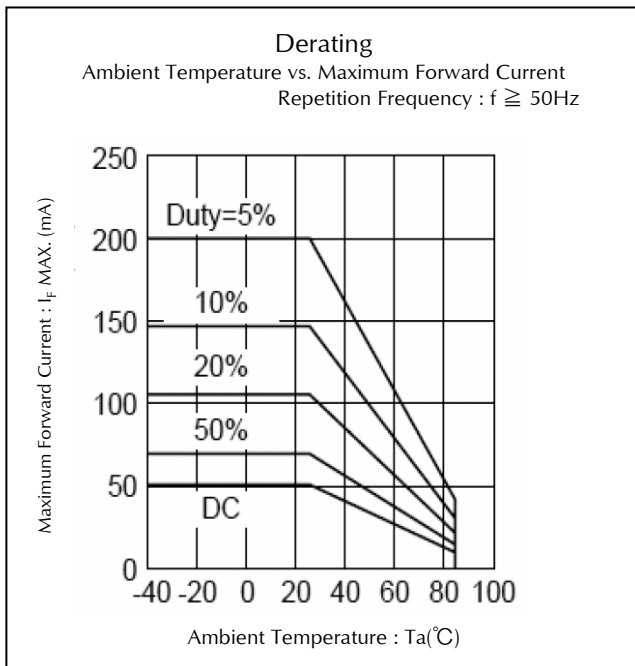

Technical Data(FR)

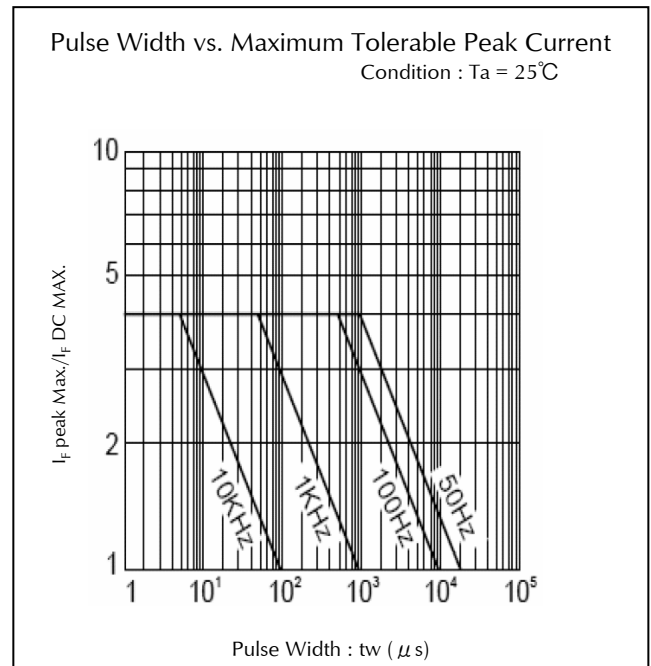
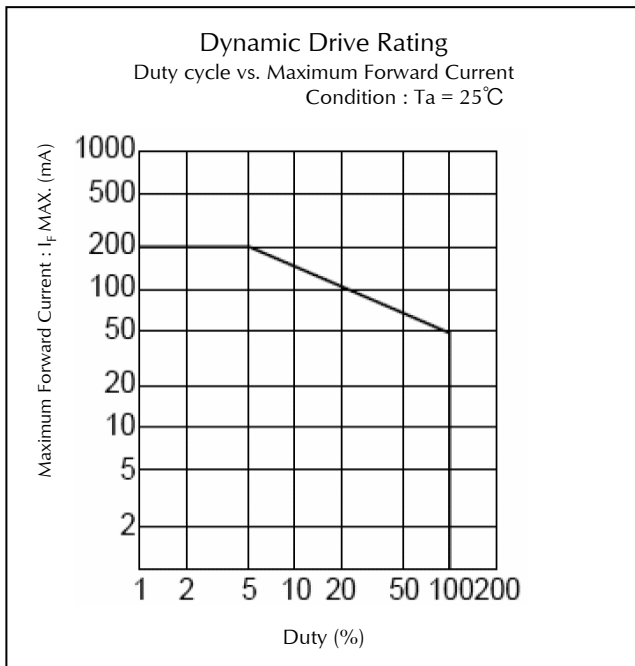

TTW (Through The Wave) soldering Conditions

Pre-heating	100 °C	(MAX.)
Solder Bath Temp.	265°C	(MAX.)
Dipping Time	5 s	(MAX.)

- 1) The dip soldering process shall be 2 times maximum.
- 2) The product shall be cooled to room temp. before the second dipping process.

※The detail is described to LED and Photodetector handling precautions of home page:
 "Mounting through-hole Type Devices" and "Soldering", and use it after the confirmation, please.

Manual Soldering Conditions

Iron tip temp.	400°C	(MAX.)
Soldering time and frequency	3 s	(MAX.)
	2 times	(MAX.)

※The detail is described to LED and Photodetector handling precautions of home page:
 "Mounting through-hole Type Devices" and "Soldering", and use it after the confirmation, please.

Reliability Testing Result

Reliability Testing Result	Applicable Standard	Testing Conditions	Duration	Failure
Room Temp. Operating Life	EIAJ ED-4701/100(101)	Ta = 25°C, If = Maximum Rated Current	1,000 h	0/25
Resistance to Soldering Heat	EIAJ ED-4701/300(302)	260±5°C, 3mm from package base	10s	0/25
Temperature Cycling	EIAJ ED-4701/100(105)	Minimum Rated Storage Temperature(30min) ~Normal Temperature(15min) ~Maximum Rated Storage Temperature(30min) ~Normal Temperature(15min)	5 cycles	0/25
Wet High Temp. Storage Life	EIAJ ED-4701/100(103)	Ta = 60±2°C, RH = 90±5%	1,000 h	0/25
High Temp. Storage Life	EIAJ ED-4701/200(201)	Ta = Maximum Rated Storage Temperature	1,000 h	0/25
Low Temp. Storage Life	EIAJ ED-4701/200(202)	Ta = Minimum Rated Storage Temperature	1,000 h	0/25
Lead Tension	EIAJ ED-4701/400(401)	10N, 1time (□0.4 and Flat Package : 5N)	10s	0/10
Vibration, Variable Frequency	EIAJ ED-4701/400(403)	98.1m/s ² (10G), 100 ~ 2KHz sweep for 20min., XYZ each direction	2 h	0/10

Failure Criteria

Items	Symbols	Conditions	Failure criteria
Luminous Intensity	Iv	If Value of each product Luminous Intensity	Testing Min. Value < Spec. Min. Value x 0.5
Forward Voltage	V _F	If Value of each product Forward Voltage	Testing Max. Value ≥ Spec. Max. Value x 1.2
Reverse Current	I _R	V _R = Maximum Rated Reverse Voltage V	Testing Max. Value ≥ Spec. Max. Value x 2.5
Cosmetic Appearance	-	-	Occurrence of notable decoloration, deformation and cracking

Special Notice to Customers Using the Products and Technical Information Shown in This Data Sheet

- 1) The technical information shown in the data sheets are limited to the typical characteristics and circuit examples of the referenced products. It does not constitute the warranting of industrial property nor the granting of any license.
- 2) For the purpose of product improvement, the specifications, characteristics and technical data described in the data sheets are subject to change without prior notice. Therefore it is recommended that the most updated specifications be used in your design.
- 3) When using the products described in the data sheets, please adhere to the maximum ratings for operating voltage, heat dissipation characteristics, and other precautions for use. We are not responsible for any damage which may occur if these specifications are exceeded.
- 4) The products that have been described to this catalog are manufactured so that they will be used for the electrical instrument of the benchmark (OA equipment, telecommunications equipment, AV machine, home appliance and measuring instrument).
The application of aircrafts, space borne application, transportation equipment, medical equipment and nuclear power control equipment, etc. needs a high reliability and safety, and the breakdown and the wrong operation might influence the life or the human body. Please consult us beforehand if you plan to use our product for the usages of aircrafts, space borne application, transportation equipment, medical equipment and nuclear power control equipment, etc. except OA equipment, telecommunications equipment, AV machine, home appliance and measuring instrument.
- 5) In order to export the products or technologies described in this data sheet which are under the "Foreign Exchange and Foreign Trade Control Law," it is necessary to first obtain an export permit from the Japanese government.
- 6) No part of this data sheet may be reprinted or reproduced without prior written permission from Stanley Electric Co., Ltd.
- 7) The most updated edition of this data sheet can be obtained from the address below:
<http://www.stanley-components.com>